

1	2		3	4	
No.	Part Name	Q'ty	Material	Processing・Finish	Remarks

A
B
C
D
E
F

A
B
C
D
E
F

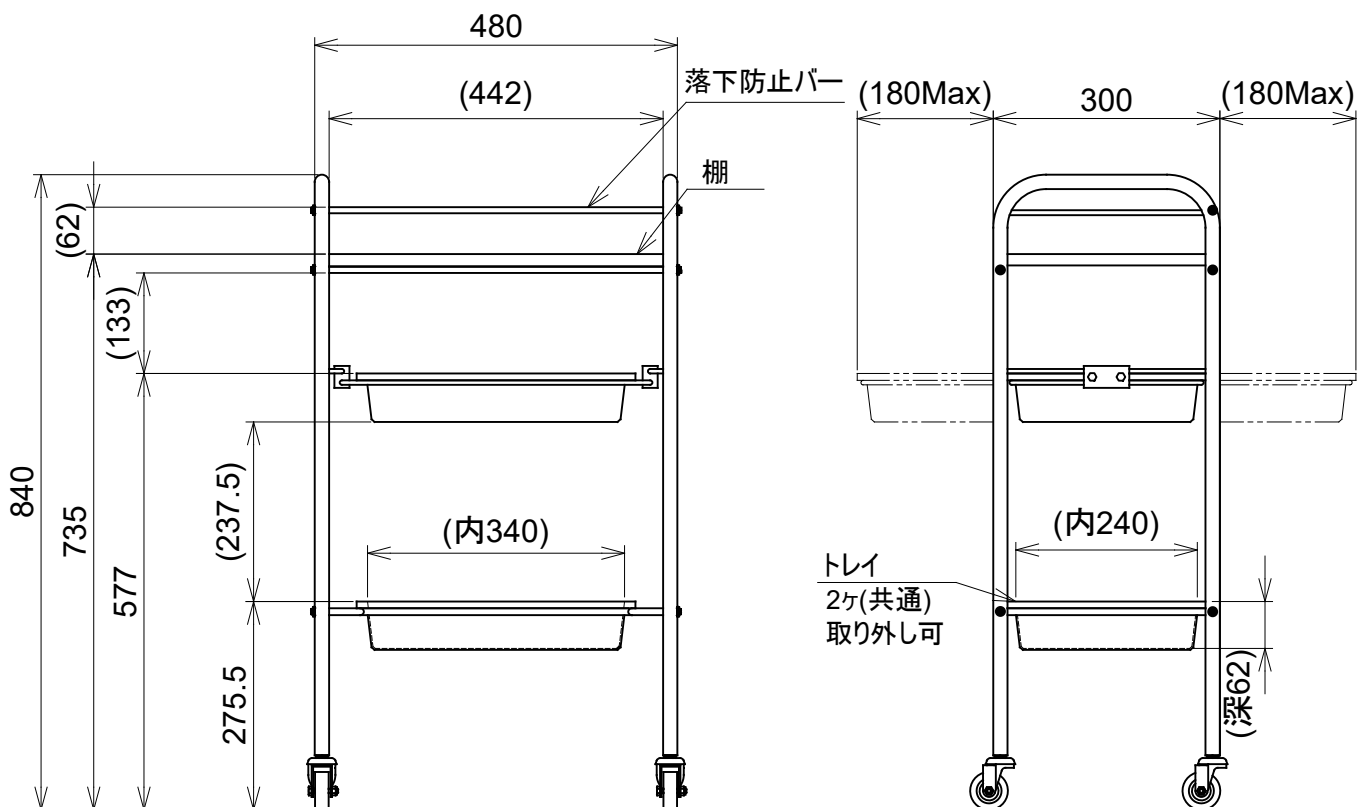
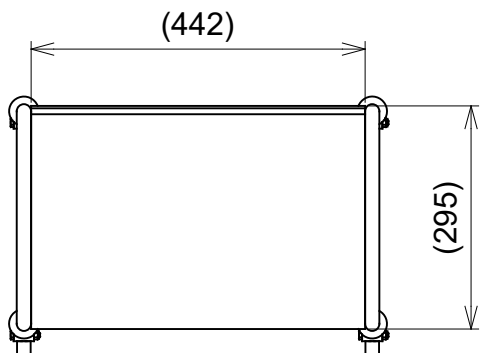

※本図面寸法は、製品により多少の誤差があります。

3rd angle projection method

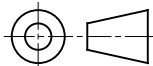

measurement unit: mm

BEAUTY GARAGE

Approved	Checked	Drawn	Date
		marukusu	2020/01/24
			Scale
			Scale= 1:10(A4)

Product name

ユーティリティワゴン 3BOX

Category

ワゴン

BG Model No.

1000000*

Title

寸法図

Version

01

Sheet No.

1/1

1

2

3

4